

International Journal of Innovative Research in Science, Engineering and Technology

(A High Impact Factor, Monthly, Peer Reviewed Journal)

Visit: www.ijirset.com

Vol. 7, Issue 4, April 2018

Suggestional & Fabricated Perpendicular Conveyor System

Akash Pravin Kharote¹, Akash Ganpat Tilekar², Wadghare Kiran Tanaji³, Deshmukh Swapnil Dipak⁴,
Gaikwad Aaditya Madhukar⁵

Lecturer, Department of Mechanical Engineering College of Navsahyadri Institute of Technology, Pune University,
Dist – Pune, Maharashtra , India¹

Student, Department of Mechanical Engineering School of Navsahyadri Institute of Technology, Pune University,
Tal- Daund, Dist – Pune, Maharashtra , India^{2,3,4,5}

ABSTRACT: The main aspect of making of this project stands in the material handling modern technology using the mode of transportation from the set point from the specific set path and certain time. The main facing problems are the tight turns specified as to be 90° for this project, the use of conveyor setup along the track which is to be cost efficient and having the high load carrying capacity. The suggested system is to be very accurate with ease in maintenance and highly reliable which can be applicable in the Automobile Industry, FMCG, etc locations which involves material transfer. This paper provides to design the conveyor system used for which includes belt speed, belt width, motor selection, belt specification, shaft diameter, pulley, gear box selection, with the help of standard model calculation.

KEYWORDS: FMCG, Conveyor, Transportation, 90 Degree.

I. INTRODUCTION

This paper is the complete study for the transportation of material in the practical scenario in the Industry also with its Proper Maintenance and some of the main required calculation for the Fabrication of the system, which involves the selection criteria of materials and components. Modern gear drives designs cost provides quick reliable services and high power intensities, which can be achieved only by raising the gears. So we made a brave step in manufacturing such a 90 degree conveyor system for material handling at a very low-cost that is early affordable and economical. Throughout the world bulk materials handling operations perform a key function in a great number and variety of industries. While the nature of the handling tasks and scale of operations vary from one floor to another and according to the industrial and economic base, the relative costs of transporting bulk materials are, in the majority of cases, quite significant. It is important, therefore, that handling systems be designed and operated with a view to achieving maximum efficiency and reliability with flexible material handling. The aim of this project is to redesign existing conveyor system by designing the critical parts (pulley, belt, gear and Frame), to minimize the overall weight of the assembly and to save considerable amount of material.

II. OBJECTIVE

Now in industries only fixed type belt conveyor is available. But we will make the conveyor belt such that it can be rotate 90° and belt will be easy to turn at sharp corners with material. The handling systems be designed and operated with a view to achieving maximum efficiency and reliability.

International Journal of Innovative Research in Science, Engineering and Technology

(A High Impact Factor, Monthly, Peer Reviewed Journal)

Visit: www.ijirset.com

Vol. 7, Issue 4, April 2018

III.METHODOLOGY

DESIGN & CALCULATIONS OF THE PROTOTYPE

- We are designing the conveyor belt system for the industries. So first we put a prototype in front of them.
- So we make the design & calculations for prototype.

DESIGN OF PROTOTYPE

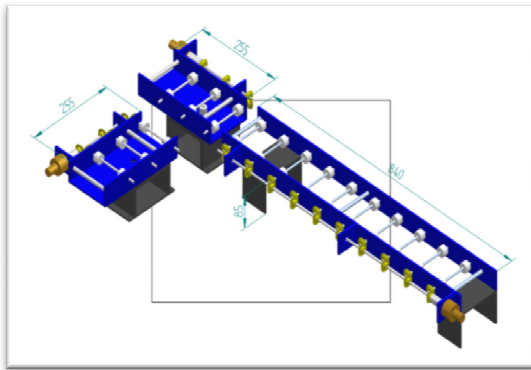

Fig1:Software model

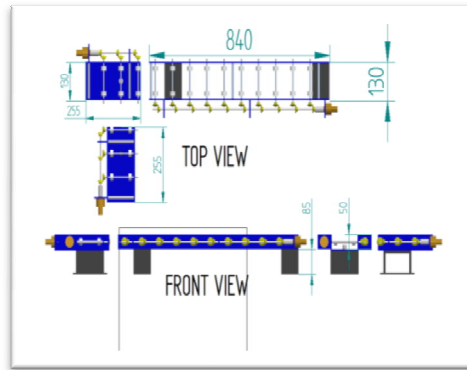

Fig2: Software model Front View

IV.CONSTRUCTION

SOFTWARE REQUIRED:

- CATIA
- AUTOCAD

V. HARDWARE / PARTS REQUIRED:

TABLE 1: SPECIFICATION CHART

SR NO	COMPONENTS	Specification								
1	Dc Motor	<ul style="list-style-type: none"> • 30 RPM 12V DC motors with Gearbox • 6 mm shaft diameter with internal hole • 125 gm weight • Stall Torque = 0.5kgcm torque (0.04903325 N-m) • No-load current = 60 mA (Max), Load current = 300 mA (Max) 								
2	Bevel Gear	<table border="1"> <tr> <td>Material – pp</td> <td>Quantity - 30</td> </tr> <tr> <td>Module =1.25</td> <td>No of teeth=23</td> </tr> <tr> <td>Bore dia. =6</td> <td>Bevel gear Angle=45</td> </tr> <tr> <td>Boss dia.=17.3</td> <td>Boss length=7</td> </tr> </table>	Material – pp	Quantity - 30	Module =1.25	No of teeth=23	Bore dia. =6	Bevel gear Angle=45	Boss dia.=17.3	Boss length=7
Material – pp	Quantity - 30									
Module =1.25	No of teeth=23									
Bore dia. =6	Bevel gear Angle=45									
Boss dia.=17.3	Boss length=7									
3	Roller / Pulley	Material – nylon Quantity – 30								

International Journal of Innovative Research in Science, Engineering and Technology

(A High Impact Factor, Monthly, Peer Reviewed Journal)

Visit: www.ijirset.com

Vol. 7, Issue 4, April 2018

		Size – $\Phi 20 \times 10\text{mm}$
4	Channel Plate	Material – Acrylic Quantity – 2 Part size - 50 x 830 x 5 mm
5	C – Turn Table Plate	Material – Acrylic Quantity – 1 Size – 50 x 225x 5 mm
6	Motor Mtg. Plate	Material – Acrylic Quantity – 6 Size – 50x 64 x 5 mm
7	Roller Bush	Material – aluminum Quantity – 3 Size – 20x 40 mm
8	Turn Table Bush	Material – Aluminum Quantity – 1 Size- $\Phi 20 \times 20 \text{ mm}$
9	Roller Shaft	Material – MS Quantity – 15 Size – $\Phi 6 \times 165 \text{ mm}$
10	Conveyor Drive Shaft	Material – MS Size- $\Phi 6 \times 800\text{mm}$ Quantity – 2 Load Capacity – 500gm
11	Turn Table Motor Shaft	Material – M.S Size- $\Phi 6 \times 200\text{mm}$ Quantity – 2 Load Capacity – 500gm
12	Leg Support	Material – Foam PVC Quantity – 4 Size – 80x130 X 5 Mm

VI. DESIGN & CALCULATIONS OF PROTOTYPE:

MATERIALS AND THEIR PROPERTIES:-

The materials used in this project are detailed as follows

Mild steel

– EN – 4 to EN – 6

Carbon – 0.15% to 0.35%

Tensile strength – 1200/1420MPa

Yield strength – 750/1170 MPA

Aluminum

Young's modulus - 70 GPa

Yield strength - 240 Mpa

Shear modulus- 26 GPa

Bulk modulus- 76 GPa

Poisson ratio- 0.35

Mohs hardness- 2.75 Vickers hardness- 2.75

Brinell hardness- 160–550 MPa

Aluminum is the most widely used non-ferrous metal, The global production of aluminium in 2005 was 31.9 million tones

FoamPVC

Density - 1.3-1.45 g/cm³

Thermal conductivity- 0.14–0.28 W/ (m·K)

Yield strength-4500–8700 psi – 640 Mpa

Young's modulus-790000 psi

Coefficient of thermal expansion- $5 \times 10^{-5} \text{ mm/ (mm } ^\circ\text{C)}$

International Journal of Innovative Research in Science, Engineering and Technology

(A High Impact Factor, Monthly, Peer Reviewed Journal)

Visit: www.ijirset.com

Vol. 7, Issue 4, April 2018

PVC is supplied in two basic forms: rigid (sometimes abbreviated as RPVC) and flexible. The rigid form of PVC is used in construction for pipes and profile applications, such as doors and windows. It is also used for bottles, other non-food packaging and cards (for example, bank cards or membership cards). It can be made softer and more flexible due to the addition of plasticizers; the most widely used are phthalates.

VII. DESIGN CONSIDERATIONS

1. Designing the system for continuous flow of material (idle time should be zero).
2. Going in for standard equipment which ensures low investment and flexibility.
3. Incorporating gravity flow in material flow system.
4. Ensuring that the ratio of the dead weight to the payload of material handling equipment is minimum.

VIII. DESIGN CALCULATIONS

Table2: Calculation Chart

Belt calculations	
Belt Capacity Capacity is the product of speed and belt cross sectional area. Generally, belt capacity B.C (kg/sec) is given as	B.C = 3.6A V ρ Where, A= belt sectional area (m2) ρ = material density (kg/m3) V= belt speed (m/s)
Area of Belt A = Length x Width A = 815 x 100 A = 81500 mm ² A = 0.081500 m²	Belt Speed $V = \frac{2\pi N}{60 \times 60} \quad V = \frac{2 \times \pi \times 10}{3600}$ V = 0.01745 m/sec
Density of Material: P = Density of material Material used for Belt is Rubber. Density of Rubber is 0.9 x 10³ kg/m³	B.C = 3.6 x A x V x ρ B.C = 3.6 x 0.081500m ² x 0.01745m/sec x 1.1 x 10 ³ B.C = 4.5 Kg/sec
Roller calculation	
Diameter of Roller (Drive Pulley) The roller support belt and facilitates easy as well as free rotation of the belt conveyor in all direction. The correct choice of roller diameter must take into consideration the belt width. The relationship between the maximum belt speed, roller diameter and the relative revolution per minute is given as $N = \frac{V \times 1000 \times 60}{D \times \pi}$	Where, N = RPM of Belt V = Speed of Belt D = Dia. Of Roller $10 = \frac{0.01745 \times 1000 \times 60}{D \times \pi}$ D = 33.32 mm D = 34 mm
Pulley calculations	
Power at Drive Pulley: $P_p = \frac{2\pi NT}{60}$ $P_p = \frac{2 \times \pi \times 10 \times 19.61}{60}$ P _p = 20 Watt. P_p = 0.02 Kw	Where, T = Torque of Drive motor T = 2 kg. m T = 19.61 N. m
Power calculations	
Power Required for Conveyor to Produced Lift: $P = \frac{C \times L \times 3.5}{1000} \quad P = \frac{4.5 \times 0.3 \times 3.5}{1000}$ P = 0.004725 Kw.	Where, P = Power required for Conveyor (Kw) C = Conveyor Capacity (Kg/sec)

International Journal of Innovative Research in Science, Engineering and Technology

(A High Impact Factor, Monthly, Peer Reviewed Journal)

Visit: www.ijirset.com

Vol. 7, Issue 4, April 2018

	L = Lift (Assume – 0.3 m.) (m)
TENSION Calculation	
Belt Tension at Steady State:	
$T_{ss} = 1.37 \times F \times L \times g (2 \times M_i + (2 \times M_b + M_m) \times \cos\theta) + H \times g \times M_m$	
$T_{ss} = 1.37 \times 0.02 \times 0.832 \times 9.81 \times \cos 30^\circ \times 0.18304$	
$T_{ss} = 0.035 \text{ KN.}$	
<p>T_{ss} = Belt tension at steady state (N). F= Coefficient of friction (0.02). L=Conveyor length (m). (Conveyor belt is approximately half of the total belt length). = 832mm = 0.832m θ = Inclination angle of the conveyor. H=Vertical height of the conveyor g = Acceleration due to gravity (9.81 m/sec²). M_i =Load due to the idlers (Considering no load). M_b=Load due to belt (0.18304 kg). M_m=Load due to conveyed materials (Considering no load).</p>	

IX. ON THE BASIS OF PROTOTYPE WE MANUFACTURED CONVEYOR IN COMPANY CONVEYOR BELT CALCULATIONS:

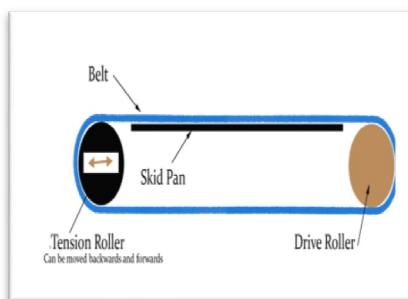

Fig3: Belt Drive

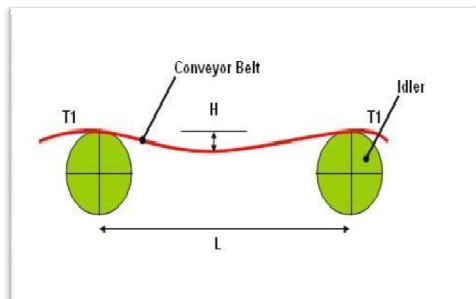

Fig4: Belt in motion when applied with Force/ motion

- ▶ Conveyor belts are used in a wide variety of material transport applications such as manufacturing, food processing, and heavy industry.
- ▶ Belts - are the most common type of conveyors and are very versatile.
- ▶ The belt consists of one or more layers of material.
- ▶ An under layer-to provide linear strength and shape called a carcass(polyester, nylon and cotton)
- ▶ An over layer called the cover. (rubber or plastic compounds)

Conveyor belt types are following:

- Round Belts
- V Belts
- Flat Belts
- Timing/Toothed Belts

THE PARAMETERS FOR DESIGN OF BELT CONVEYOR:

- Belt speed
- Belt width

International Journal of Innovative Research in Science, Engineering and Technology

(A High Impact Factor, Monthly, Peer Reviewed Journal)

Visit: www.ijirset.com

Vol. 7, Issue 4, April 2018

- Absorbed power
- Final Product passes through
- Drive pulley shaft

X. INPUT DATA

Table 3: Input consideration

SR.NO	CONSTARIN	VALUE
1	Conveyor capacity (Cc)	1500*(t/h)=416.67 Kg/sec
2	Belt speed (V)	1.5 m/sec
3	Conveyor height (H)	20 m
4	Conveyor length (L)	250 m
5	Conveyor capacity (Cc)	1500*(t/h) = 416.67 Kg/sec
6	Mass of a set of idlers (m'i)	20 Kg
7	Idler spacing (l')	1.2 m
8	Load due to belt (mb)	25 Kg/m
9	Inclination angle of the conveyor (δ)	5°
10	Coefficient of friction (f)	0.02
11	Start-up factor (Ks)	1.5
12	Drive efficiency (Kd)	0.9
13	Friction factor (Cr)	15
14	Breaking strength loss factor (Cv)	0.75

XI.PULLEY CALCULATIONS FOR COMPANY

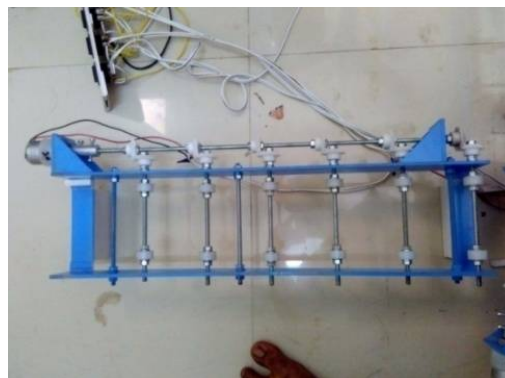

Fig5: Pulley

- A **conveyor pulley** is a mechanical device used to change the direction of the belt in a conveyor system, to drive the belt, and to tension the belt.
- Modern pulleys are made of rolled shells with flexible end disks and locking assemblies.
- Conveyor belt pulleys vary in diameter and width on different applications.
- The diameter of the pulley must be large enough to prevent ply separation of the belt composition due to flexing over small pulleys.
- The pulley diameter is thus a function of the number of belt plies and material construction.
- Therefore, the standard rule is that the diameter of the drive head pulley should not be smaller than 125 times the number of plies in the belt.

International Journal of Innovative Research in Science, Engineering and Technology

(A High Impact Factor, Monthly, Peer Reviewed Journal)

Visit: www.ijirset.com

Vol. 7, Issue 4, April 2018

- Pulleys are made up of several components including the shell, end disk, hub, shaft and locking assembly.
- The end disk and hub may be on piece.
- The locking assembly may also be replaced with a hub and bushing on lower tension pulleys.
- The shell is also referred to as the rim in some parts of the world.

XII. SELECTION OF A CONVEYOR PULLEY

When selecting a pulley for a belt conveyor application, specifications will be determined by addressing the following steps:

Table 4: Standard Procedure Steps

STEP 1	The Face Length of the Conveyor Pulley
STEP 2	The Anticipated Belt Tension of the Conveyor System
STEP 3	The Outer Diameter & Shaft Diameter of the Conveyor Pulley
STEP 4	The Style of Hub Connection
STEP 5	The Pulley Configuration
STEP 6	The Profile of the Pulley Face
STEP 7	The Appropriate Component Materials
STEP 8	The Type of Contact Surface Required
STEP 9	Other Important Specifications

Pulleys are manufactured in a wide range of sizes. The selection of pulley takes into account the wrap angle (180°), belt speed (1.5 m/sec), method of belt strain, belt tension T , belt width (1200 mm) and type of splice of the conveyor belt. The pulley diameter is obtained from standard value from the catalogue. Once the pulley diameter is determined, the size of the coupling can also be decided from the catalogue.

XIII. ADVANTAGES

The 90 degree conveyor system for material handling has all abundant and outstanding advantage of this equipment in any material handling industry with minimum knowledge about the operation of equipment is very limited time.

- Low manufacturing cost of the equipment.
- Easy to handle.
- Less weight.
- Compact in size.
- Cost of checking the error is less.
- All kinds of material can be handled.
- Even a lay man can work in it.

XIV. LIMITATION

- Accumulation difficult.
- Continuous or periodic monitoring of belt is necessary.
- Heat affects the material of belt

XV. APPLICATIONS

- Used in automobile industry
- Can be applied in gear manufacturing unit.
- Used in airport.

International Journal of Innovative Research in Science, Engineering and Technology

(A High Impact Factor, Monthly, Peer Reviewed Journal)

Visit: www.ijirset.com

Vol. 7, Issue 4, April 2018

- Also used in stone crushing industry.
- Used in both small scale industries as well as the large scale industries
- Its outcome can be utilized properly to a great executed in mechanical field as well as the automobile field.
- Also used in Warehouses
- In coal industry
- Food and packaging industry

XVI. RESULT/FIBRICATION

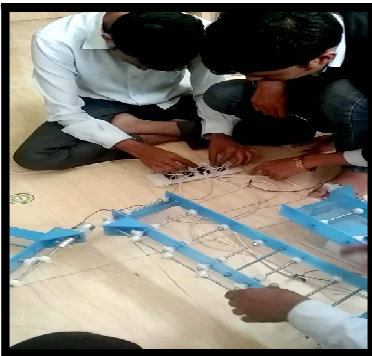

Fig6: Model Making

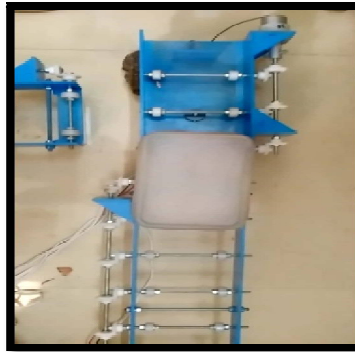

Fig7: Top view of System

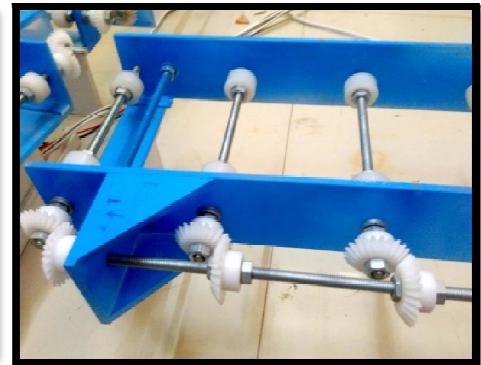

Fig8: Gears in the System

XVII. CONCLUSION

This projects proves that this type of 90⁰ perpendicular system can be fabricated and operated in the Industry which will be very beneficial for the users and also it's now easy to fabricate as per the Requirement. The transfer of Materials at very small is also possible and this system is cheap to fabricate and operate in short time.

REFERENCES

- [1]A.w. roberts and a. Harrison [1] "RECENT RESEARCH DEVELOPEMENTS IN BELT CONVEYOR TECHNOLOGY"
- [2]Sunderesh S. Heragu and BanuEkren[2] "MATERIALS HANDLING SYSTEM DESIGN"
- [3]Aniket. A. Jagtap et al [3] "DESIGN OF MATERIAL HANDLING EQUIPMENT: BELT CONVEYOR SYSTEM FOR CRUSHED BIOMASS WOOD USING V MERGE CONVEYING SYSTEM" IJMERR Vol. 4, No. 2, April 2015 ISSN 2278 – 0149
- [4]Michael G. Kay [4] "Material Handling Equipment"
- [5]N.Sivakumar [5] "Design and Fabrication of Industrial Conveyor Using Crank Mechanism" IRJET Volume: 03 Issue: 04 Apr-2016 ISSN: 2395 - 0056
- [6]D.K. Nannaware [6] "Design and Optimization of Roller Conveyor System" IJSER Volume 5, Issue 7, July-2014 ISSN 2229-5518
- [7]Charles Malmberg et al [7] "AN INTRODUCTION TO MATERIAL HANDLING EQUIPMENT SELECTION" College-Industry Council on Material Handling Education (CICMHE)